

# ESSENZA ACUTE CARE RANGE

**LINET**

Turn to the Essence of Care

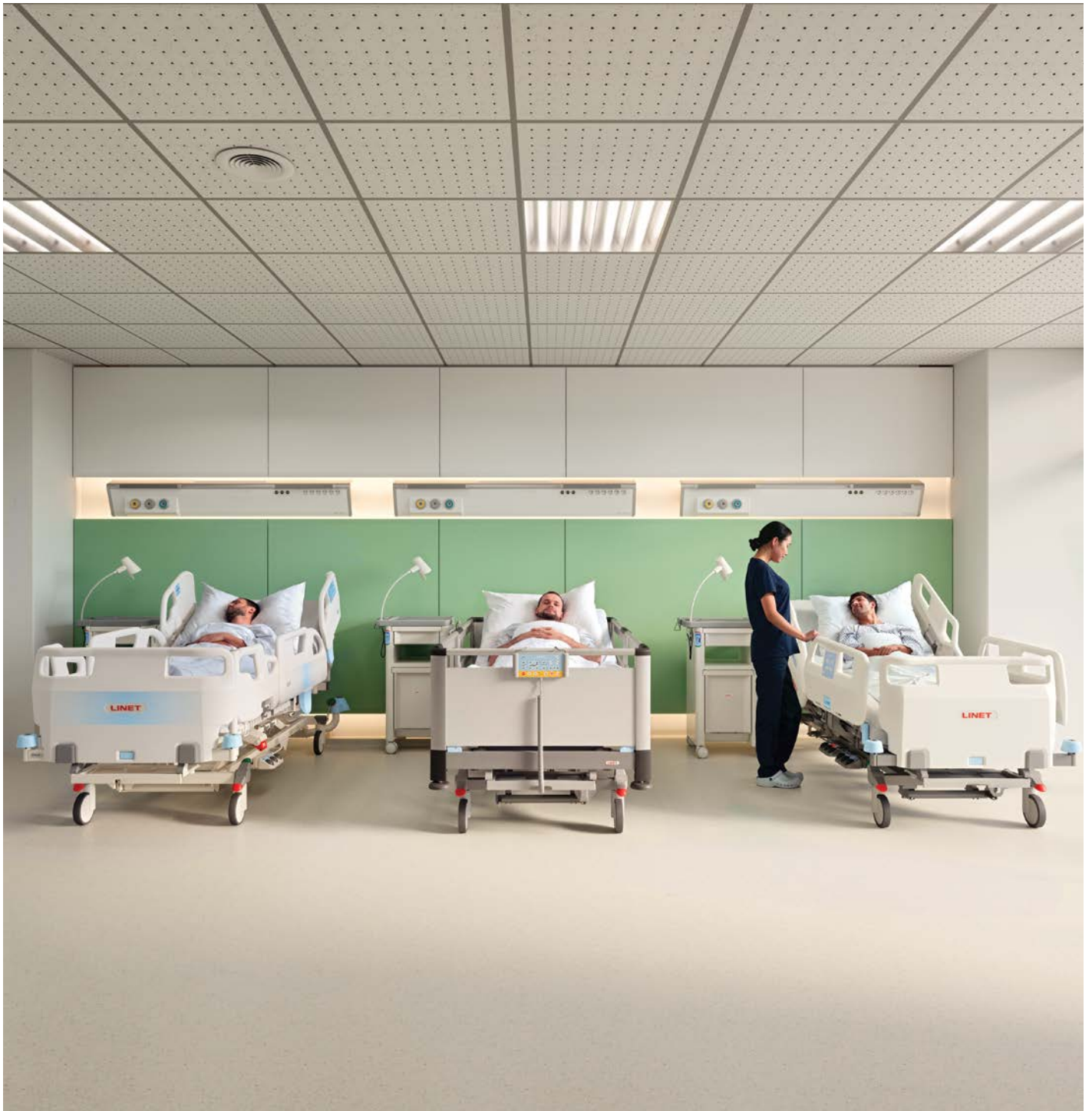

One Platform that Fits Every Level of Acute Care

# THE GLOBAL NURSES SHORTAGE



Nurses guide patients through their most vulnerable moments, yet today they are asked to do more with less. As nurse shortages grow and administrative demands increase, time for what matters most, patient care, is disappearing.

At the same time, workflows are becoming more complex, with different beds, controls, and systems across wards. This means more time adapting and less time caring, putting pressure on caregivers, healthcare efficiency, costs, and patient outcomes. It is time to simplify.

Introducing the Essenza acute care range, a unified platform designed to reduce complexity across wards, standardize workflows, and support caregivers in their daily routines.

One platform. The same experience. Across every level of care. Because when things work the same, care becomes safer, faster, and more focused on the patient.

## Turn to the Essence of Care.



**77%**

of nurses suffer from work-related musculoskeletal disorders<sup>1</sup>



**75%**

of falls are unwitnessed<sup>2</sup>

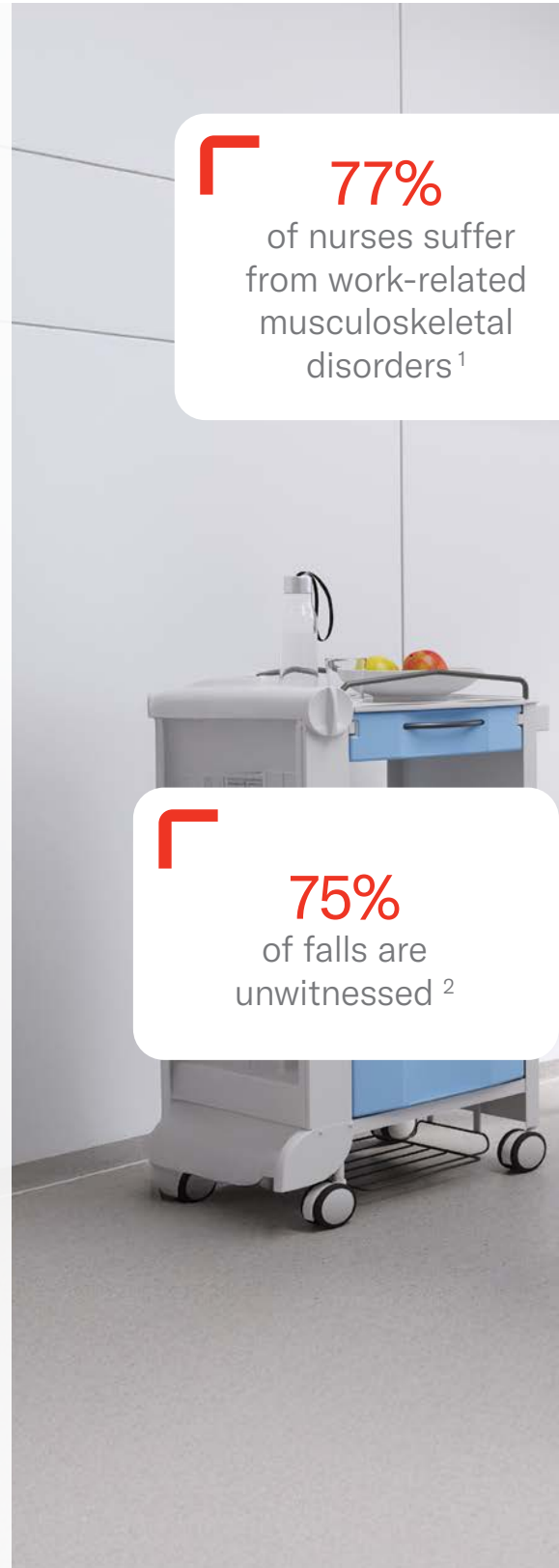

# ESSENZA ACUTE CARE RANGE

TURN TO THE ESSENCE OF CARE

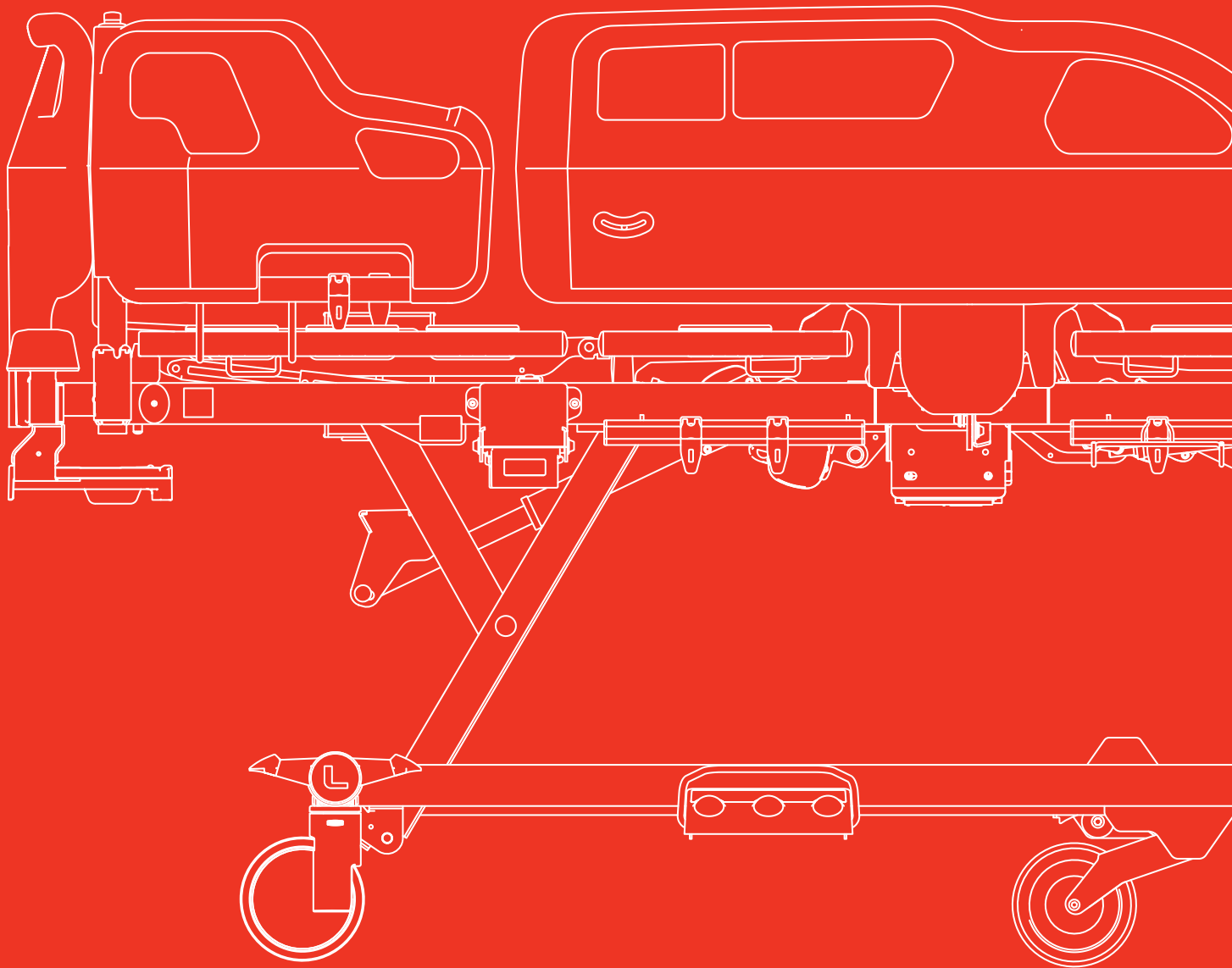



**6-18.5%**  
HAPI prevalence in  
acute care<sup>4</sup>

**11.5 days**  
longer hospital stay  
after a fall<sup>5</sup>

**41%**  
of caregivers lack time  
for patient care<sup>3</sup>

# SUPERIOR SAFETY & ERGONOMICS DRIVEN BY NURSE- AND PATIENT-CENTRIC DESIGN



**Lateral Tilt** reducing physical strains on the caregiver by 67%.<sup>6</sup>



**Mobi-Controls®** can help to speed up the recovering process.



**Low Bed Height of 25.5 cm** helps to reduce the severity of patients' falls.



**EasyDrive®** enables effortless patient transportation done by one caregiver.<sup>7</sup>

# UNPARALLELED EFFECTIVENESS BROUGHT BY ADVANCED TECHNOLOGIES

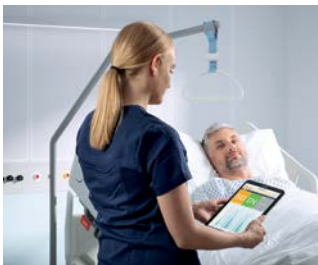

**SafeSense** helps to save time by giving a remote overview of the patient.



**Integrated Mattresses** provides caregivers with easy, time-saving care management.



**DesignInk®** contributes to reducing patient fear and anxiety while improving the working environment for caregivers.<sup>8</sup>



**SmartTracking** facilitates caregivers' daily work by tracking hospital assets or patients.

# ONE PLATFORM THAT FITS EVERY LEVEL OF ACUTE CARE



**Hospital-Wide Standardisation** reduces complexity and total cost.



**Clinical Versatility** adapts to every patient and acuity level.



**Intuitive Workflows** streamline onboarding and help prevent errors.



**Common Components** simplify service and reduce downtime.

# ESSENZA ACUTE CARE RANGE

A unified acute care bed range built on a single platform that reduces complexity, standardizes workflows, supports infection control, and enables a simpler, more efficient bed fleet across the hospital.

## ESSENZA 100 & 200

Designed for Safety,  
Made for Comfort



## ESSENZA 300

Efficiency of a Single Platform  
Unlocking Incredible Versatility

## ESSENZA 300 W

Efficient Hygiene Control enabled by  
Complete Washable Solution



## ESSENZA 300 JUNIOR+

Continuity of Care  
from Junior to Adult

# ENHANCED PATIENT OUTCOMES



## EARLY MOBILIZATION

Mobi-Controls® promote patient mobilization, which can potentially decrease the length of hospital stay and all the associated complications.<sup>9</sup>



## PRESSURE INJURY PREVENTION

Ergoframe® and wide range of mattresses enhance patient comfort and pressure relief, addressing various levels of injury risk with tailored support solutions.



## FALLS PREVENTION

The 3 siderail concept and safety features like low bed height, brake alert & bed exit alert by SafeSense provide enhanced protection and reduce the risk and severity of patient falls.



## IMPROVE PATIENT EXPERIENCE

Patient empowering controls, DesignInk® and USB integration enhance comfort and autonomy, reducing stress and improving the patient experience.



# IMPROVED CAREGIVER & HOSPITAL WORKFLOW



## SAFE PATIENT MOVING & HANDLING

Lateral tilt, foot controls & auto-countour support safe and ergonomic patient handling, reducing caregiver strain and improving patient positioning.



## EASY PATIENT TRANSPORTATION

EasyDrive®, 5th castor and SoftBrakes® ensure easy maneuverability and safer patient transportation.



## SIMPLIFY CAREGIVER PROCEDURES

Solutions like SafeSense, SmartTracking and mattress integration streamline workflows, saving time and reducing the burden on staff for more efficient care.



## HOSPITAL OPERATIONS EFFICIENCY

Standardized accessories, a washable solution, and one platform for both junior and adult patients help streamline hospital workflow, support infection control, and simplify bed fleet management across the hospital.





# EARLY MOBILIZATION

## CHALLENGE

- Complications associated with long hospital stay.<sup>10</sup>
- Longer length of hospital stay due to immobility.<sup>11</sup>
- Increased costs for the hospital.<sup>10</sup>

**\$3 025**

Average daily costs  
of hospital care<sup>12</sup>

**6.59 days**

Average length of stay  
at acute care ward<sup>13</sup>

### Neurological

Depression, anxiety, delirium, forgetfulness and confusion.



### Respiratory/ pulmonary

Pneumonia, atelectasis, VAP, pulmonary embolism.



### Renal

Stasis, nephritis, catheter-associated urinary tract infections.



### Musculoskeletal

Muscle Atrophy, weakness and contractures are seen in 25–90% of patients with prolonged hospitalization.<sup>37</sup>



### Cardiovascular

Cardiac muscle atrophy, hemodynamic instability and DVT.



### Gastrointestinal

Altered patterns of elimination, incontinence, constipation, fecal impaction.



### Metabolic

Acid-Base Balance, Metabolic Syndrom.



### Skin

Pressure ulcers. Lack of mobility increases the risk of pressure injury development.

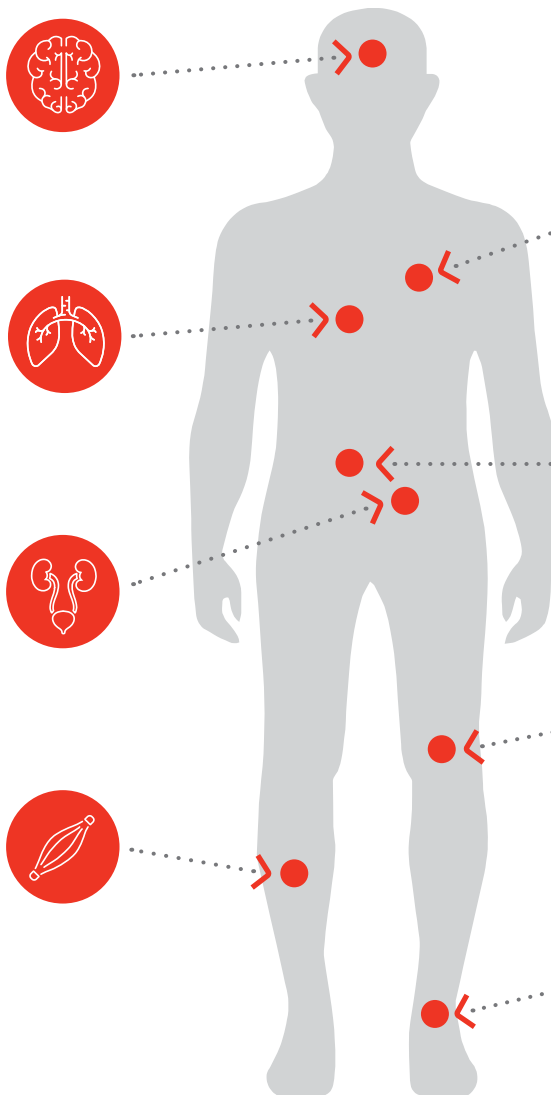

# SOLUTION

Mobi-Controls® promote patient mobilization, which can potentially decrease the length of hospital stay and all the associated complications.<sup>9</sup>

Length of hospital stay decreased by  
**1.5 days**<sup>9, 14</sup>

In Hospital Falls reduced by  
**37%**<sup>9</sup>

Hospital associated infections reduced by  
**60%**<sup>9</sup>

	LEVEL 0	LEVEL 1	LEVEL 2	LEVEL 3	LEVEL 4
MOVEMENTS					
CRITERIA	<b>BED IMMOBILE</b> • Clinically stable, but not able to cooperate in care.	<b>BED ACTIVE</b> • Able to cooperate in self-care and bedbound.	<b>ABLE TO SIT</b> • Strong enough to sit upright and able to move leg against gravity.	<b>ABLE TO STAND</b> • Increased strength for standing activities and actively participates in transfers to chair.	<b>ABLE TO WALK</b> • Tolerates walking in the room and independently transfers to chair.
SOLUTIONS	<ul style="list-style-type: none"> <li>• Lateral Tilt (300   300 W)</li> <li>• Head of Backrest**</li> <li>• Reverse Trendelenburg</li> <li>• Vascular Leg Position</li> </ul>	<ul style="list-style-type: none"> <li>• Lateral Tilt (300   300 W)</li> <li>• Head of Backrest**</li> <li>• Reverse Trendelenburg</li> <li>• Vascular Leg Position</li> <li>• Mobi-Grips</li> <li>• Cardiac Chair*</li> </ul>	<ul style="list-style-type: none"> <li>• Mobi-Pad* (300)</li> <li>• Mobi-Grips*</li> <li>• Cardiac Chair*</li> <li>• Mobi-Lift® (300)</li> <li>• Mobi-Rail® (100   200)</li> </ul>	<ul style="list-style-type: none"> <li>• Mobi-Lift® (300)</li> <li>• Mobi-Grips*</li> <li>• Mobi-Pad* (300)</li> <li>• Lateral Tilt* (300   300 W)</li> <li>• Mobi-Rail® (100   200)</li> </ul>	<ul style="list-style-type: none"> <li>• Mobi-Lift® (300)</li> <li>• Mobi-Grips*</li> <li>• Mobi-Pad* (300)</li> <li>• Lateral Tilt* (300   300 W)</li> <li>• Mobi-Rail® (100   200)</li> </ul>

## LESS DEMANDING STANDING PROCEDURE<sup>15</sup> (300)

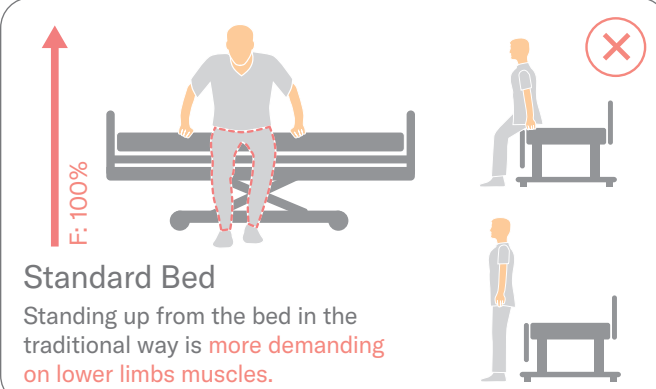

**Standard Bed**  
Standing up from the bed in the traditional way is **more demanding** on lower limbs muscles.

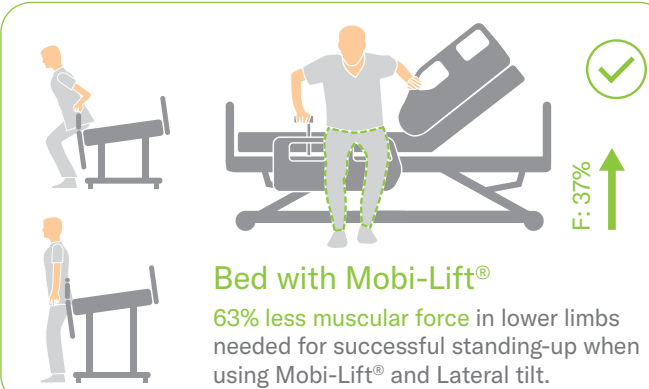

**Bed with Mobi-Lift®**  
63% less muscular force in lower limbs needed for successful standing-up when using Mobi-Lift® and Lateral tilt.

\* This tool intends to support the improvement of outcomes for patients and Health Care Professionals. Please be advised that the purpose is to offer guidance and does not replace the need for clinical assessment/judgement.  
\*\* Availability of automatic stop at 30° varies by Essenza model and configuration



# PRESSURE INJURY PREVENTION

## CHALLENGE

- Worldwide prevalence of HAPI varies from 6% to 18.5% in the acute care segment.<sup>4</sup>
- Pressure injuries can develop within minutes due to immobility.<sup>16</sup>
- The average cost of pressure injury treatment ranges from €1 419 to €16 299.<sup>17</sup>



# SOLUTION

Ergoframe® and wide range of mattresses enhance patient comfort and pressure relief, addressing various levels of injury risk with tailored support solutions.

## ERGOFRAME® (AUTO-CONTOUR)

Unique frame design increases patient comfort and reduces peak pressure in the pelvic area by 16%.<sup>18</sup>

**Standard Bed**

Most affected areas by extensive pressure and shearing forces.

**Bed with Ergoframe®**

- 16% reduction in peak pressure in pelvic area.<sup>18</sup>
- Sliding down prevention.<sup>18</sup>

Higher comfort  
Reduced sliding  
Minimum patient migration  
Reducing shearing forces

## WIDE RANGE OF MATTRESSES FOR ESSENZA

To provide high patient comfort and prevention of pressure injuries, LINET offers a wide choice of mattresses for Essenza according to the needs of patients with different risk levels of pressure injury development.



### Active Mattresses

Air2Care mattress family featuring 2-cell alternating technology, and the Virtuoso mattress family offering advanced 3-cell alternating technology.

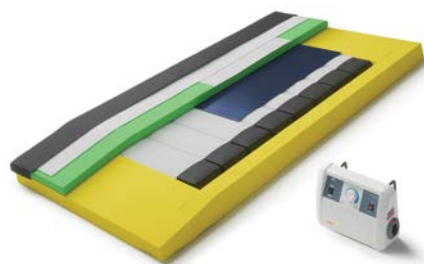

### Hybrid Mattresses

HybriMatt mattress family, offering a combination of active and passive systems in one.



### Passive Mattresses

ViskoMatt mattress range, including a viscoelastic foam layer, as well as advanced MediMatt mattresses.



# FALLS PREVENTION

## CHALLENGE

- Falls are one of the most commonly reported patient safety incidents in hospital settings.<sup>5</sup>
- **75%** of falls are unwitnessed.<sup>2</sup>
- In-hospital falls can result in hospital stays that are **11.5 days** longer.<sup>5</sup>
- The cost per patient fall is estimated at **£2 600**.<sup>19</sup>



# SOLUTION

The **3 siderail concept** and safety features like **low bed height**, **brake alert** & **bed exit alert by SafeSense** provide enhanced protection and reduce the risk and severity of patient falls.



## LOW BED HEIGHT

Helps to reduce the severity of patients' falls.

300 | 300 J\* | 300 W

## BED EXIT ALERT BY SAFESENSE

Notifies staff whenever a patient leaves the bed while providing continuous monitoring combined with bed exit notifications, resulting in:

- Helps prevent fall incidents
- Enables quicker reactions to patients at risk of falling



100 | 200

## 3 SIDERAIL CONCEPT

Optional third siderail provides full protection or an escape route when needed.

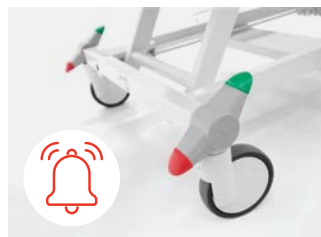

200 | 300 | 300 J\* | 300 W

## BRAKE ALERT

Bed automatically emits an audible signal when it is left unbraked while the main power cable is connected.

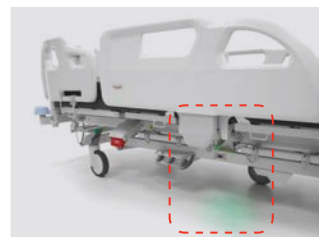

200 | 300 | 300 J\* | 300 W

## LOWEST POSITION INDICATOR

Green LED light is triggered when the bed reaches lowest position.



200 | 300 | 300 J\* | 300 W

## NIGHT LIGHT

Undercarriage light helps with patient orientation in the room overnight.



# IMPROVE PATIENT EXPERIENCE

## CHALLENGE

- Stressful environment and patient discomfort.<sup>20</sup>
- **Lack of autonomy** causes stress in patients, which impacts blood pressure and weakens the immune system.<sup>21</sup>
- **Clear communication** is crucial during times of stress and fear.<sup>22</sup>
- Children's small size, weight, and morphology require a suitable healing environment.<sup>23</sup>



# SOLUTION

Patient empowering controls, DesignInk® and USB integration enhance comfort and autonomy, reducing stress and improving the patient experience.

## PATIENT EMPOWERING CONTROLS

Patient can easily reach bed controls while sitting or lying.



**Handset**  
Designed for use by both patients and caregivers.



**Mobi-Pad**  
Supports the patient during early mobilization.

300



**Integrated Controls**  
Allow the patient to ergonomically position the backrest and thigh res.

200 | 300 | 300 W

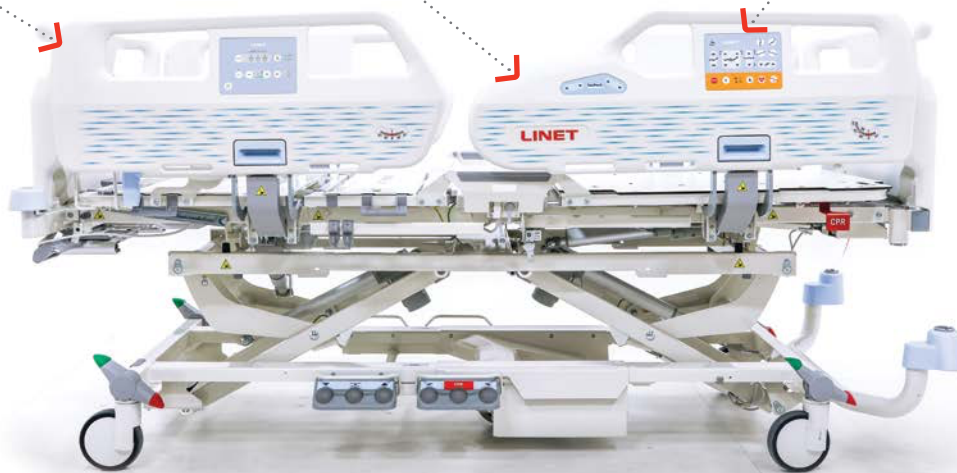

## DESIGNINK®

Contributes to reducing patient fear and anxiety while improving the working environment for caregivers.<sup>8</sup>



## USB INTEGRATION

The integrated USB port allows smart devices to be utilized safely from the bed.

200 | 300 | 300 J\*



## SAFE SIDERAILS FOR JUNIORS

Advanced siderail design engineered to safeguard both junior and adult patients from entrapment risks.

300 J\*



## BED EXTENSION\*

Easy one-hand extension allows quick, effortless length adjustment for taller patients.

\* Essenza 100 & Essenza 200 have a different bed extension mechanism.



# SAFE PATIENT MOVING & HANDLING

## CHALLENGE

- 20% of nurses' working time is spent on patient mobility and handling.<sup>24</sup>
- The annual prevalence of work-related MSDs among nurses is 77%.<sup>1</sup>
- Nurses turn immobile patients 11 times per shift.<sup>25</sup>
- Caregivers are still at top of the number of work-related MSD's.<sup>26</sup>
- 47% of caregivers' MSDs are back injuries, leading to staff shortages and time constraints.<sup>3</sup>



# SOLUTION

Lateral tilt, foot controls & auto-countour support safe and ergonomic patient handling, reducing caregiver strain and improving patient positioning.

## FRAME-BASED LATERAL TILT



- Skin assessment
- Patient hygiene
- Positioning
- Bed making

The traditional way of turning the patient can lead to a back injury

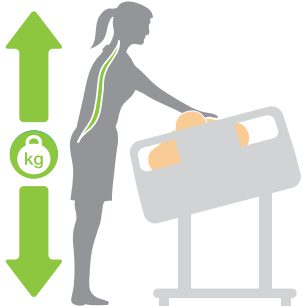

Lateral tilt for ergonomically correct care

300 | 300 W

- 67%  
of forces needed  
for turning the patient<sup>6</sup>

- 20%  
of compression of lumbar  
spine during patient handling<sup>6</sup>



## FOOT CONTROLS\*

Operating lateral tilt and bed height ensures ergonomic positioning for caregivers and effective handling of the patient.

## AUTO-CONTOUR

Patient is less likely to slide down in the bed when the back rest and thigh rest are elevated together. Caregivers do not need to repeatedly reposition the patient up in the bed.



\* Essenza 200 is available with foot controls only for bed height adjustment.



# EASY PATIENT TRANSPORTATION

## CHALLENGE

- Pushing and pulling occupied beds are considered high-risk tasks for developing MSDs due to spinal load.<sup>27</sup>
- Nurses spend **31 minutes** per day transporting and transferring patients.<sup>28</sup>
- An occupied bed needs to be transported by **2 caregivers**.<sup>29</sup>



# SOLUTION

EasyDrive<sup>®</sup>, 5th castor and SoftBrakes<sup>®</sup> ensure easy maneuverability and safer patient transportation.

## EASYDRIVE<sup>®</sup>

Enables effortless patient transportation done by one caregiver without the need for any initial pushing force for acceleration.<sup>7</sup>

300

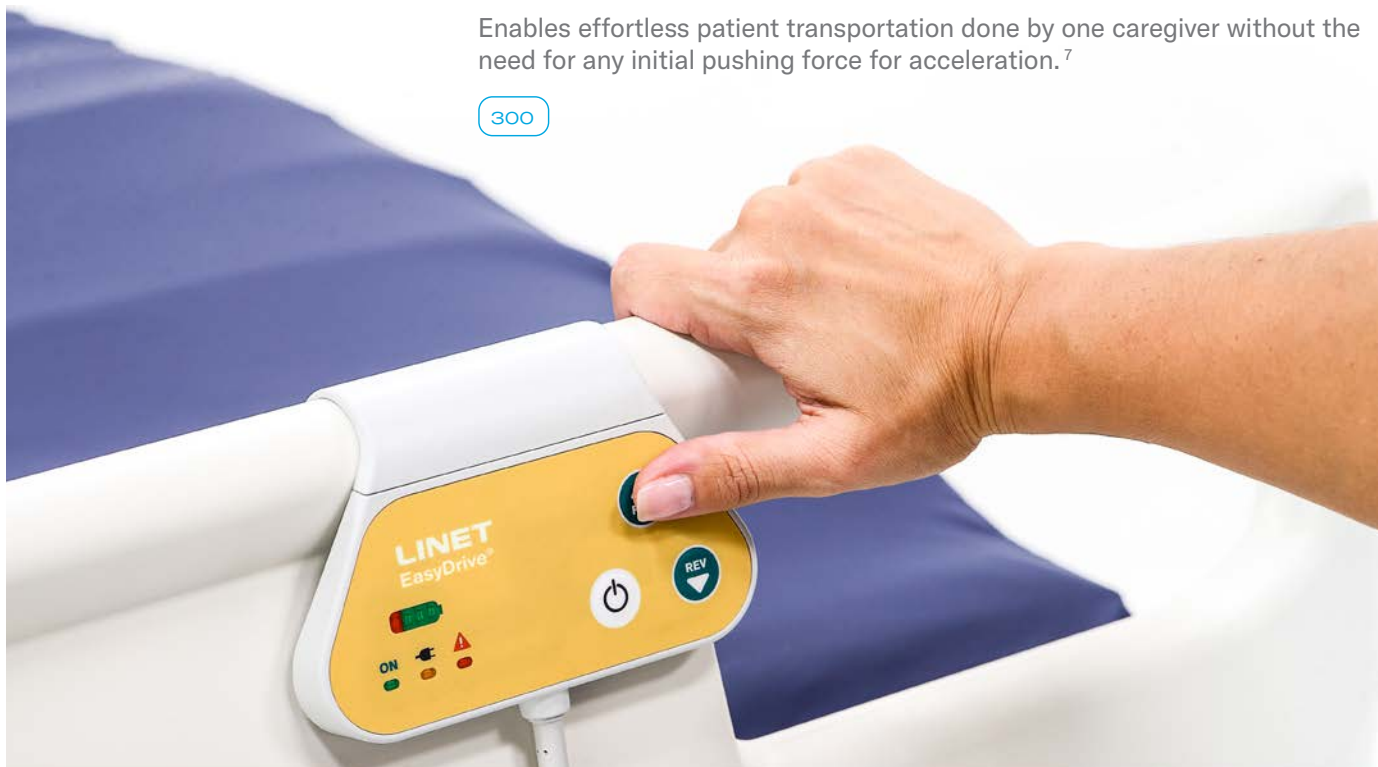

## 5<sup>TH</sup> CASTOR

Enables easier turning and maneuvering of the bed, even in narrow corridors or around corners.

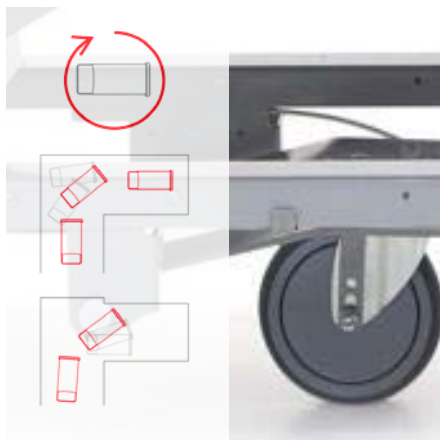

## SOFTBRAKES<sup>®</sup>

Ensure effortless pedal activation, offering a 56–93% force reduction compared to the maximum acceptable level.<sup>30</sup>



## TRANSFER OF THE PATIENT

Lateral tilt makes the transfer of the patient from bed to bed easier.<sup>25</sup>

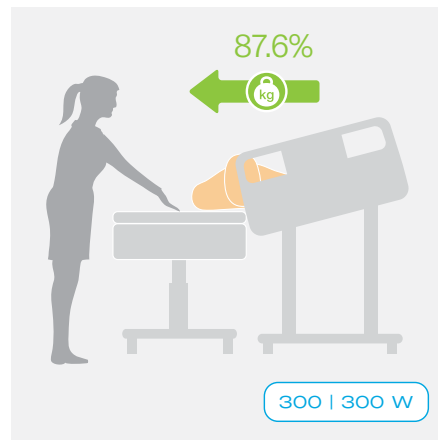



# SIMPLIFY CAREGIVER PROCEDURES

## CHALLENGE

- Patient care can be compromised because of the insufficient number of registered nurses.<sup>31</sup>
- Inconsistent device design across product lines can lead to use-related hazards, particularly during emergency response.<sup>32</sup>
- **15.6%** of nurses reported burn-out.<sup>33</sup>
- **41%** of caregivers suffer a lack of time.<sup>3</sup>

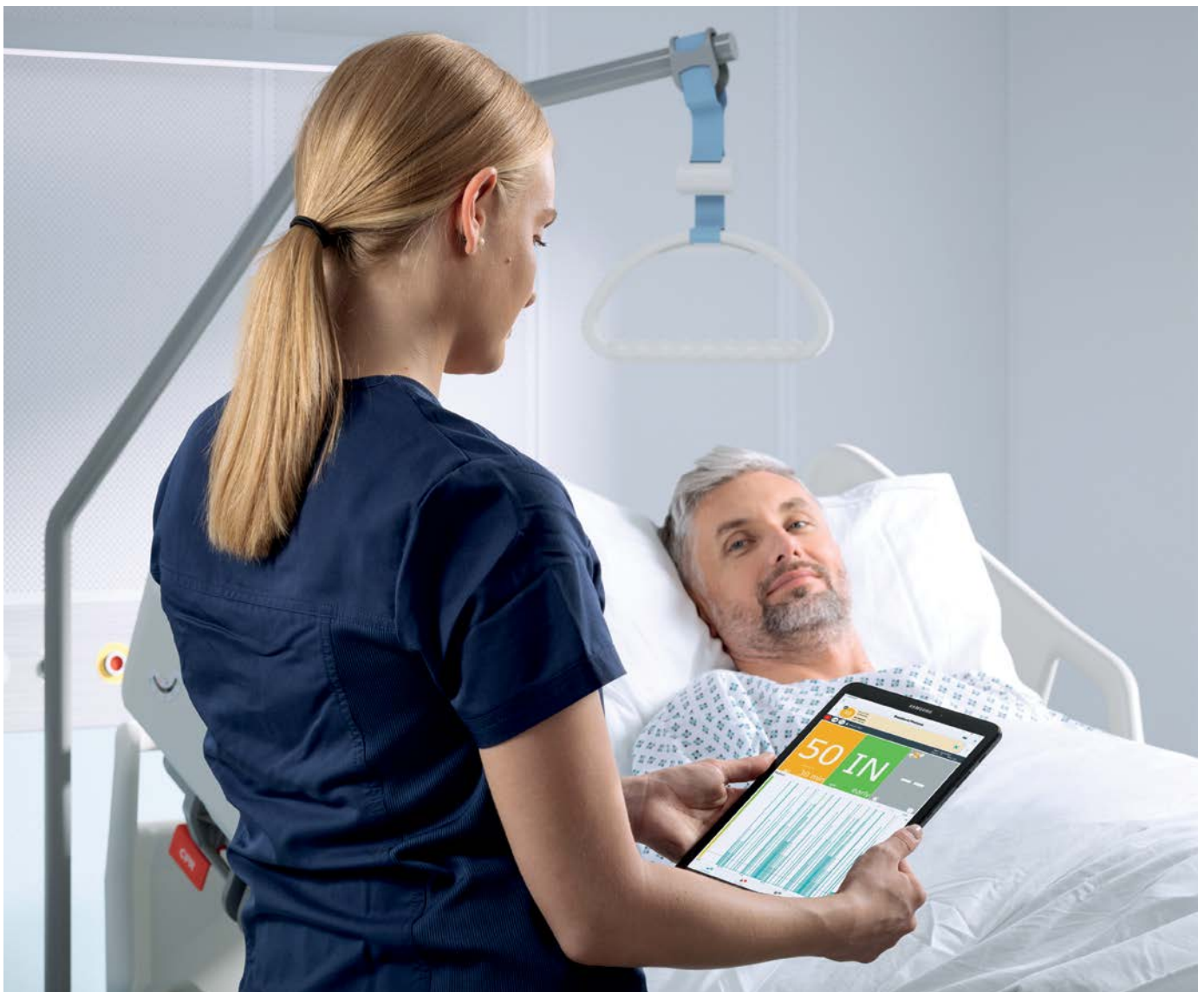

# SOLUTION

Solutions like **SafeSense**, **SmartTracking** and **mattress integration** streamline workflows, saving time and reducing the burden on staff for more efficient care.

## MATTRESS INTEGRATION

Integrated directly into the bed, enabling easy mattress adjustments while saving space and reducing vibration.



300

## SAFESENSE

Smart care solution that helps to save time by giving a remote overview of the patient and reduces the number of unnecessary operations.

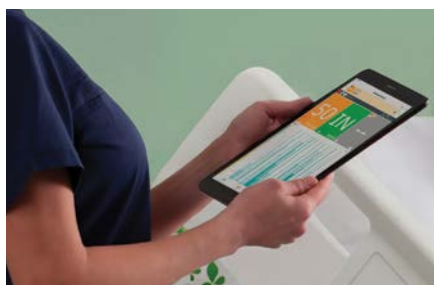

## SMARTTRACKING

A unique smart concept that performs asset and patient tracking and enables caregivers to find equipment remotely with room-level accuracy.



## CAREGIVER EMPOWERING CONTROLS

Standardized designs simplify the training process, enabling staff to become proficient with equipment quickly.



**Attendant Control Panel**  
Convenient positioning allows for easy bed adjustments.

200 | 300 | 300 J\* | 300 W

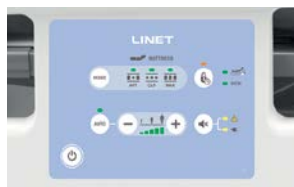

**Mattress Control Panel**  
Allows easy setting of the mattress.

300



**Foot Controls for Height and Tilt Adjustments\***  
Enables hands-free height adjustment and lateral tilt adjustments.

200 | 300



**Siderail Control Panel**  
Convenient positioning allows for easy bed adjustments.

200 | 300 | 300 W



\* Essenza 200 is available only with foot controls for bed height.



# HOSPITAL OPERATION EFFICIENCY

## CHALLENGE

- The most contaminated surfaces in patient rooms are flat surfaces, including the floor, as well as hospital beds, mattresses, and furniture.<sup>34</sup>
- Hospital-acquired infections cannot be reduced without infection control measures.<sup>35</sup>
- **43%** of nurses report having insufficient time for documentation.<sup>36</sup>



# SOLUTION

Standardized accessories, washable solution, and one platform for both junior and adult patients help streamline hospital workflow, support infection control, and simplify bed fleet management across the hospital.

## ACCESSORIES COMPATIBILITY ACROSS THE ESSENZA RANGE

A standardized line of accessories ensures compatibility with Essenza 100, 200, and 300. This standardization delivers key benefits:

- Enhances workflow for healthcare professionals across all departments
- Reduces variability caused by incompatibility issues



## WASHABLE SOLUTION

The acuity adaptable hospital bed ensuring compliance with the highest hygiene standards in variable design options.



## ONE PLATFORM FOR BOTH JUNIOR AND ADULT PATIENTS

One universal frame, engineered in line with the key safety principles of EN 50637:2017 and EN 60601-2-52, delivering safety for both junior and adult populations.



# ESSENZA PORTFOLIO & KEY FEATURES OVERVIEW

## ENHANCED PATIENT OUTCOMES

	EZ 300	EZ 300 W	EZ 300 JUNIOR <sup>+</sup>	EZ 200	EZ 100
 <b>Early Mobilization</b>	<div style="width: 100%; height: 10px; background-color: red;"></div>	<div style="width: 90%; height: 10px; background-color: red;"></div>	<div style="width: 80%; height: 10px; background-color: red;"></div>	<div style="width: 90%; height: 10px; background-color: red;"></div>	<div style="width: 90%; height: 10px; background-color: red;"></div>
Lateral Tilt	○	○	—	—	—
Mobi-Lift <sup>®</sup>	○	—	—	—	—
Mobi-Pad	○	—	—	—	—
Mobi-Rail <sup>®</sup>	—	—	—	○	○
Mobi-Grips	●	●	●	●	●
 <b>Pressure Injury Prevention</b>	<div style="width: 100%; height: 10px; background-color: red;"></div>	<div style="width: 90%; height: 10px; background-color: red;"></div>	<div style="width: 90%; height: 10px; background-color: red;"></div>	<div style="width: 90%; height: 10px; background-color: red;"></div>	<div style="width: 90%; height: 10px; background-color: red;"></div>
Mattress Integration	○	—	—	—	—
Ergoframe <sup>®</sup>	●	●	●	●	●
Wide Range of Compatible Mattresses	●	—	●	●	●
 <b>Falls Prevention</b>	<div style="width: 90%; height: 10px; background-color: red;"></div>	<div style="width: 90%; height: 10px; background-color: red;"></div>	<div style="width: 90%; height: 10px; background-color: red;"></div>	<div style="width: 90%; height: 10px; background-color: red;"></div>	<div style="width: 90%; height: 10px; background-color: red;"></div>
Low Bed Height	●	●	●	—	—
SafeSense	○	○	○	○	—
 <b>Improve Patient Experience</b>	<div style="width: 90%; height: 10px; background-color: red;"></div>	<div style="width: 90%; height: 10px; background-color: red;"></div>	<div style="width: 90%; height: 10px; background-color: red;"></div>	<div style="width: 90%; height: 10px; background-color: red;"></div>	<div style="width: 90%; height: 10px; background-color: red;"></div>
DesignInk <sup>®</sup>	○	○	○	○	○
USB Integration	○	—	○	○	—
Patient Integrated Controls	○	○	—	○	—

● Standard ○ Optional — Not available



**Mobi-Controls<sup>®</sup>** help to speed up the recovering process.



**Mattress Integration** improves patient comfort by reducing vibration.



**Ergoframe<sup>®</sup>** makes patient positioning more comfortable.



























**Low Bed Height** helps to reduce the severity of patients' falls.



**DesignInk<sup>®</sup>** contributes to reducing patient fear and anxiety while improving the working environment for caregivers.<sup>8</sup>

# IMPROVED CAREGIVER & HOSPITAL WORKFLOW

	EZ 300	EZ 300 W	EZ 300 JUNIOR*	EZ 200	EZ 100
 <b>Safe Patient Moving &amp; Handling</b>					
Lateral Tilt	○	○	—	—	—
Foot Controls	○	—	—	○	—
Mobi-Rail®	—	—	—	○	○
Auto-Contour	●	●	●	●	●
 <b>Easy Patient Transportation</b>					
EasyDrive®	○	—	—	—	—
SoftBrakes®	○	○	○	○	○
5 <sup>th</sup> Castor	○	○	○	○	○
 <b>Simplify Caregivers Procedures</b>					
Mattress Integration	○	—	—	—	—
Caregiver Integrated Controls	○	—	○	○	—
SafeSense	○	○	○	○	—
 <b>Hospital Operations Efficiency</b>					
Accessories Compatibility	●	●	●	●	●
Washable Solution	—	●	—	—	—
One Platform for Juniors and Adults	—	—	●	—	—

● Standard ○ Optional — Not available



**Lateral Tilt** reduces the effort needed to turn a patient by up to 67%.<sup>6</sup>



**EasyDrive®** enables effortless patient transportation done by one caregiver.<sup>7</sup>



**SoftBrakes®** castors makes operation of the brake levers easier with less physical strain.



**SafeSense** helps to save time by giving a remote overview of the patient.



**Washable Solution** ensures compliance with the highest hygiene standards.



**One Platform for Juniors and Adults** is engineered to meet safety principles for both patient groups.

## IMPROVED CAREGIVER INTERACTION

Personalized designs can include elements that facilitate better communication and interaction between staff. For instance, siderails can include informational graphics to help caregivers easily identify the department to which the product belongs.

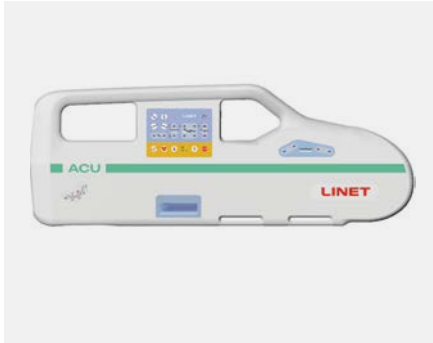

ACU



ICU



Other

## ENHANCED PATIENT COMFORT AND HEALING

The advanced printing technology allows for personalized and aesthetically pleasing designs on siderails, which create a more welcoming and less clinical atmosphere. This customization helps in reducing patient anxiety and fear, providing psychological comfort that is conducive to faster healing and recovery.<sup>8</sup>



### HIDDEN ANIMALS

Hidden animals gradually reveal themselves, inviting children to explore, imagine, and discover something new with every glance.



### FIND THE LUCKY CLOVER

A small four-leaf clover hidden in plain sight invites children to search, focus, and enjoy a quiet moment of luck and discovery.



### HOBBIES

Simple shapes slowly reveal themselves, inviting people to look closer, imagine stories, and discover new details over time.

## SUSTAINABILITY AND HYGIENE

Our printing technology uses eco-friendly materials and processes, ensuring that the designs are not only beautiful but also sustainable. Additionally, the printed surfaces are easy to clean and maintain, supporting a hygienic hospital environment.

# TECHNICAL SPECIFICATIONS

TECHNICAL PARAMETERS	ESSENZA 300	ESSENZA 300 W	ESSENZA 300 JUNIOR+	ESSENZA 200	ESSENZA 100
Safe Working Load	300 kg 270 kg (with LT)	300 kg 270 kg (with LT)	300 kg	250 kg	250 kg
Maximum Patient Weight (application environment 1;2/3;5)	235 kg / 265 kg 205 kg / 235 kg (with LT)	235 kg / 265 kg 205 kg / 235 kg (with LT)	235 kg / 265 kg	185 kg / 215 kg	185 kg / 215 kg
Average Bed Weight	165 kg 185 kg (with LT)	165 kg 185 kg (with LT)	165 kg	165 kg	165 kg
External Dimensions in Standard Bed Position (length x width)	219 cm / 221 cm (with UN:31) 99.5 cm	219 cm / 221 cm (with UN:31) 99.5 cm	219 cm / 221 cm (with UN:31) 99.5 cm	221 cm / 226 cm (with UN:02) 99.5 cm	221 cm / 226 cm (with UN:02) 99.5 cm
Minimum Bed Height	Tente Linea 125 mm 25.5 cm / 39.4 cm (with LT)	Tente Linea 125 mm 25.5 cm / 39.4 cm (with LT)	Tente Linea 150 mm 28 cm	Tente Integral 125 mm 37 cm	Tente Integral 125 mm 37 cm
Maximum Backrest/ Thighrest/ Calfrest Angle	70° / 35° / 25°	70° / 35° / 25°	70° / 35° / 25°	70° / 35° / 25°	70° / 35° / 25°
Trendelenburg / Reverse Trendelenburg Position	14° / -14°	14° / -14°	14° / -14°	15° / -15°	15° / -15°



# ACCESSORIES

A unified acute care bed range built on a single platform that reduces complexity, standardizes workflows, supports infection control, and enables a simpler, more efficient bed fleet across the hospital.



Oxygen Tank Holder  
(Vertical and Horizontal)



Urine Sack and Bottle Holder



IV Pole

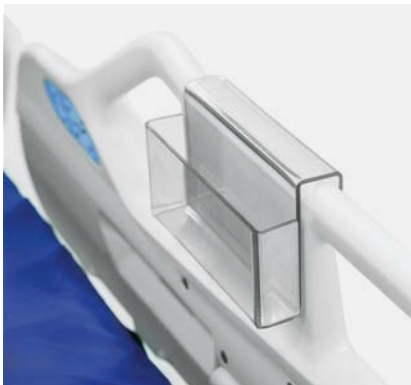

Handy Box Transparent



Lifting Pole



Universal Utility Shelf



Notes Holder



Pediatric Triangular Holders

# LINET SERVICES

## AFTER SALES

Reliable warranty and post-warranty support, including preventive maintenance, spare parts, repairs, and expert technical service.



## RENTAL

Flexible rental solutions tailored to your organization's needs, providing practical support when purchasing is not the right option.



## CUSTOMER TRAINING

Comprehensive staff training delivered worldwide through virtual reality, online learning, and hands-on practice.



# SUPERIOR SAFETY & ERGONOMICS DRIVEN BY NURSE- AND PATIENT-CENTRIC DESIGN

Caregivers face physical strain every day. Essenza helps reduce this burden through smarter ergonomics, supporting safer handling, less fatigue, and more comfortable care for patients.



# UNPARALLELED EFFECTIVENESS BROUGHT BY ADVANCED TECHNOLOGIES

By combining smart technologies with integrated solutions, Essenza simplifies daily routines, improves patient comfort, and enables more proactive and efficient care.



# ONE PLATFORM THAT FITS EVERY LEVEL OF ACUTE CARE

A single, consistent platform adapts to different patient needs and care settings, helping standardise workflows, reduce complexity, and improve overall efficiency across the hospital.



## REFERENCES

- Sun W, Yin L, Zhang T, et al. Work-related musculoskeletal disorders among nurses: meta-analysis. *Iran J Public Health*. 2023;52(3):463–475. doi:10.18502/ijph.v52i3.12130
- Francis-Coad J, Hill AM, Jacques A, et al. Characteristics of injurious falls and preventive interventions in acute units. *J Gerontol A Biol Sci Med Sci*. 2020;75(10):e152–e158. doi:10.1093/geron/glaa032
- European Agency for Safety and Health at Work (EU-OSHA). *Musculoskeletal disorders in the healthcare sector*. 2020.
- Tervo-Heikkinen TA, Heikkilä A, Koivunen M, et al. Pressure injury prevalence and incidence in acute inpatient care: national cross-sectional study. *Int Wound J*. 2022;19(4):919–931. doi:10.1111/iwj.13692
- LeLaurin JH, Shorr RI. Preventing falls in hospitalized patients: state of the science. *Clin Geriatr Med*. 2019;35(2):273–283. doi:10.1016/j.cger.2019.01.007
- LINET. MCX LINET Report: Lateral tilt—effect of lateral tilt on patients turning. 2019.
- LINET. White paper: Streamlining patient transport and maximizing operational efficiency. 2023.
- Qin SY. Analysis on the color design of hospital landscape. *Appl Mech Mater*. 2015;744–746:2196–2199. doi:10.4028/www.scientific.net/AMM.744-746.2196
- Whittington Health NHS. Help Whittington Health to #EndPIParalysis. 2018.
- Bai AD, Dai C, Srivastava S, et al. Risk factors, costs and complications of delayed hospital discharge: retrospective cohort study. *BMC Health Serv Res*. 2019;19:935. doi:10.1186/s12913-019-4760-3
- Cortes OL, Delgado S, Esparza M. In-hospital mobilization for patients admitted for medical treatment: systematic review and meta-analysis. *J Adv Nurs*. 2019;75(9):1823–1837. doi:10.1111/jan.13958
- Milliken M. Hospital and surgery costs. *Debt.org*. 2025. Available from: <https://www.debt.org/medical/hospital-surgery-costs/>.
- World Health Organization (WHO). Average length of stay, acute care hospitals only. n.d.
- Lisi C, Caspani P, Bruggi M, et al. Early rehabilitation after elective total knee arthroplasty. *Acta Biomed*. 2017;88(4S):56–61. doi:10.23750/abm.v88i4-S.5154
- MCX LINET Report Mobi-Lift with lateral tilt - Patient mobilization. 2019
- Gefen A, Brienza DM, Cuddigan J, et al. Contemporary understanding of pressure ulcer/injury aetiology. *Int Wound J*. 2022;19(3):692–704. doi:10.1111/iwj.13667
- Ramos-Sánchez A, Martínez-Beltrán MJ, Egea-Zerolo B, et al. Cost of illness of pressure injuries in a socio-health center in Spain. *Adv Skin Wound Care*. 2025;38(2):E6–E11. doi:10.1097/ASW.0000000000000272
- LINET. White paper: Pressure injury prevention of Sprint 200. n.d.
- Chartered Society of Physiotherapy (CSP). Regulator reveals 250,000 falls were reported in England's NHS last year. 2017.
- Alzahrani N. Effect of hospitalization on adult patients' emotional and psychological well-being: integrative review. *Appl Nurs Res*. 2021;61:151488. doi:10.1016/j.apnr.2021.151488
- Schreuder E, Lebesque L, Bottenheft C. Healing environments: what design factors matter according to patients? *HERD*. 2016;10(1):87–105. doi:10.1177/1937586716643951
- Hirshberg EL, Butler J, Francis M, et al. Persistence of patient and family experiences of critical illness. *BMJ Open*. 2020;10(4):e035213. doi:10.1136/bmjopen-2019-035213
- Nicoli S, Benevento M, Ferorelli D, et al. Patient safety management in pediatric settings: overview. *Front Pediatr*. 2022;10:919710. doi:10.3389/fped.2022.919710
- Al Johani WA, Pascua GP. Manual handling training and lifting devices and back pain risk among nurses: integrative review. *Nurse Media J Nurs*. 2019;9(2):210–230. doi:10.14710/nmjn.v9i2.26435
- LINET. White paper: Fighting against MSD by lateral tilt. 2023.
- U.S. Bureau of Labor Statistics. Number and rate of nonfatal work injuries in detailed private industries. 2020.
- Waters TR, Nelson A, Proctor C. Patient handling tasks with high risk for musculoskeletal disorders in critical care. *Crit Care Nurs Clin North Am*. 2007;19(2):131–143. doi:10.1016/j.ccell.2007.02.008
- Michel O, Garcia Manjon AJ, Pasquier J, Ortoleva Bucher C. How do nurses spend their time? A time and motion analysis of nursing activities in an internal medicine unit. *J Adv Nurs*. 2021;77(11):4459–4470. doi:10.1111/jan.14935
- Waters T, Lloyd JD, Hernandez E, Nelson A. AORN ergonomic tool 7: pushing, pulling, and moving equipment on wheels. *AORN J*. 2011;94(3):254–260. doi:10.1016/j.aorn.2010.08.035
- LINET. White paper: Activation forces of Softbrake (Essenza platform). 2025.
- Royal College of Nursing (RCN). Guidance on safe nurse staffing levels in the UK. 2010 (updated 2021).
- U.S. FDA, Center for Devices and Radiological Health. Applying human factors and usability engineering to medical devices. 2018.
- PRC Custom Research. National Nursing Engagement Report: Trends and implications with nursing engagement. 2019.
- EOScu. Most touched and most contaminated surfaces in a hospital room. 2020.
- Blot S, Ruppé E, Harbarth S, et al. Healthcare-associated infections in adult ICU patients: changes and new technologies. *Intensive Crit Care Nurs*. 2022;70:103227. doi:10.1016/j.iccn.2022.103227
- Berlin G, Burns F, Hanley A, et al. Understanding and prioritizing nurses' mental health and well-being: survey. *American Nurses Foundation; McKinsey & Company*. 2023.
- Koukourikos K, Tsaloglidou A, Kourkouta L. Muscle atrophy in intensive care unit patients. *Acta Inform Med*. 2014;6(4):406-10. doi: 10.5455/aim.2014.22.406-410.



Members of LINET Group

LINET spol. s r.o. | Železčice 5, 274 01 Slaný | Czech Republic  
tel.: +420 312 576 400 | fax: +420 312 522 668 | e-mail: [info@linet.com](mailto:info@linet.com) | [www.linet.com](http://www.linet.com)

